

Application

Designed for installation on potable water lines to protect against both backsiphonage and backpressure of polluted water into the potable water supply. The Model 350 shall provide protection where a potential health hazard does not exist. Ideal for use where lead-free* valves are required.

Standards Compliance : (Sizes 2 1/2"-10" Horiz. & Vert.)
(Size 12" horizontal)

- ASSE® Listed 1015
 - CSA® Certified B64.5
 - IAPMO® Listed
 - AWWA Compliant C510, and C550
 - UL® Classified
 - C-UL® Classified
 - FM® Approved (2 1/2" - 10")
 - Approved by the Foundation for Cross Connection Control and Hydraulic Research at the University of Southern California
 - NYC MEA 50-01-M (2 1/2" - 3")
 - NYC MEA 297-98-M (4" - 6")
 - NYC MEA 316-01-M (8" - 10")
 - Meets the requirements of NSF/ANSI 61*
- *(0.25% MAX. WEIGHTED AVERAGE LEAD CONTENT)

Materials

Main valve body Ductile Iron ASTM A 536
 Access covers Ductile Iron ASTM A 536
 Coatings NSF Approved fusion epoxy finish
 Internals Stainless steel, 300 Series
 NORYL™
 Fasteners Stainless Steel, 300 Series
 Seal ring EPDM (FDA approved)
 O-ring Buna Nitrile (FDA approved)
 Springs Stainless Steel, 300 Series

Features

Sizes: 2 1/2", 3", 4", 6", 8", 10", 12"
 Maximum working water pressure 175 PSI
 Maximum working water temperature 140°F
 Hydrostatic test pressure 350 PSI
 End connections
 (Grooved for steel pipe) AWWA C606
 (Flanged) ANSI B16.1
 Class 125



Options

(Suffixes can be combined)

- with NRS shut-off valves (standard)
- FSC - with epoxy coated wye type strainer (flanged only 2-1/2"-10")
- G - with groove end gate valves (2-1/2" - 10")
- GF - with grooved inlet connection and flanged outlet connection (2-1/2" - 10")
- FG - with flanged inlet connection and grooved outlet connection (2-1/2" - 10")
- L - less shut-off valves (flanged body connections)
- OSY - with OS & Y gate valves
- PI - Post Indicator gate valve
- BG - with grooved end butterfly valves with integral supervisory switches (2-1/2" - 10")
- 509 - with AWWA C509 gate valves

Accessories

- Repair kit (rubber only)
- Thermal expansion tank (Model XT)
- OS & Y Gate valve tamper switch (OSY-40)

Attention: Model 350 (flange body) and 350A (grooved body) have different lay lengths.

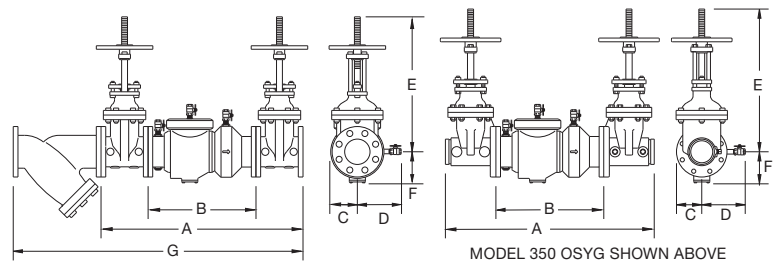

Dimensions & Weights (do not include pkg.)

MODEL 350 SIZE	DIMENSION (approximate)														WEIGHT																				
	A		A WITH BUTTERFLY VALVES		B LESS GATE VALVES		C		D		E OS&Y OPEN		E OS&Y CLOSED		E NRS GATE		E WITH BUTTERFLY VALVES		F		G		LESS SHUTOFF VALVES		NRS GATE VALVES FLANGED		NRS GATE VALVES GROOVED		OSY GATE VALVES FLANGED		OS&Y GATE VALVES GROOVED		BUTTERFLY VALVES GROOVED		
	in.	mm	in.	mm	in.	mm	in.	mm	in.	mm	in.	mm	in.	mm	in.	mm	in.	mm	in.	mm	in.	mm	in.	mm	in.	mm	in.	mm	in.	mm	in.	mm	in.	mm	in.
2 1/2	65	31	787	28	711	15 7/8	403	3 3/4	95	7 1/4	184	17 3/4	451	15 3/8	391	11 1/2	292	8 1/4	210	3 1/2	89	41 1/4	1048	53	24	155	70	137	62	163	74	145	66	125	57
3	80	32	813	28 1/2	724	15 7/8	403	3 3/4	95	7 1/4	184	20 1/4	514	17	432	12 3/4	324	8 1/2	216	3 1/2	89	42 3/4	1086	53	24	177	80	147	67	183	83	135	61	105	48
4	100	37 5/8	956	32 7/8	835	19 1/2	495	4 1/2	114	8	203	22 1/2	572	18 1/4	464	14 1/2	368	9	229	6	152	52 3/4	1340	91	41	271	123	253	115	281	127	267	121	175	79
6	150	44 3/4	1137	37 5/8	956	23 1/2	597	6	152	10	254	30 1/2	775	24 1/4	616	18	457	10 1/4	260	7	178	62 3/4	1594	165	75	449	204	421	191	465	211	439	199	283	129
8	200	60 3/4	1543	53 7/8	1369	37 3/4	959	10	254	11	279	37	940	28 1/2	724	21 1/8	537	12	305	8 1/2	216	85	2159	358	162	810	367	776	352	834	378	786	357	532	241
10	250	63 3/4	1619	57 7/8	1470	37 3/4	959	10	254	11	279	45 5/8	1159	34 3/4	883	24 3/4	629	13	330	8 1/2	216	93 1/4	2369	388	176	1148	521	1082	491	1206	547	1140	517	776	352
12	300	66 1/4	1683	n/a	n/a	38	965	10	254	12	305	53	1346	40 1/2	1029	28	711	n/a	n/a	9	229	100	2539	447	203	1493	677	n/a	n/a	1607	729	n/a	n/a	n/a	n/a

MODEL 350 2 1/2", 3" & 4" (STANDARD & METRIC)

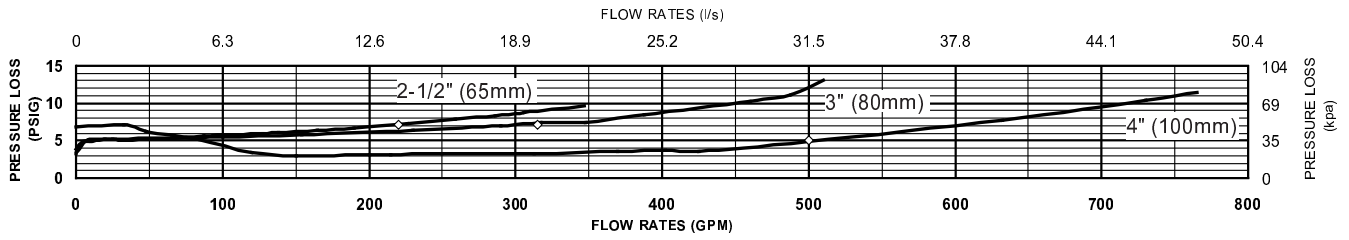

MODEL 350 6" & 8" (STANDARD & METRIC)

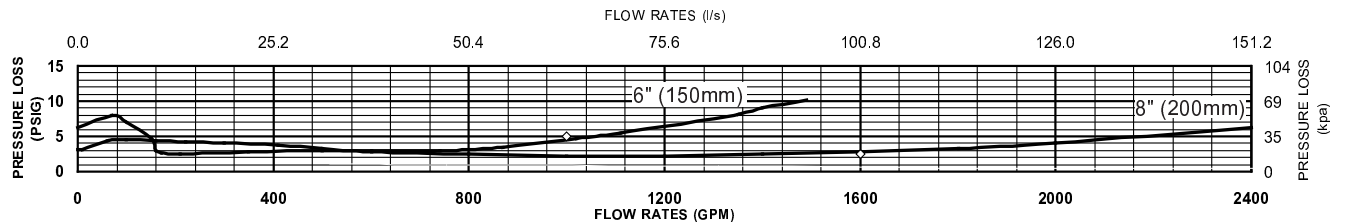

MODEL 350 10" & 12" (STANDARD & METRIC)

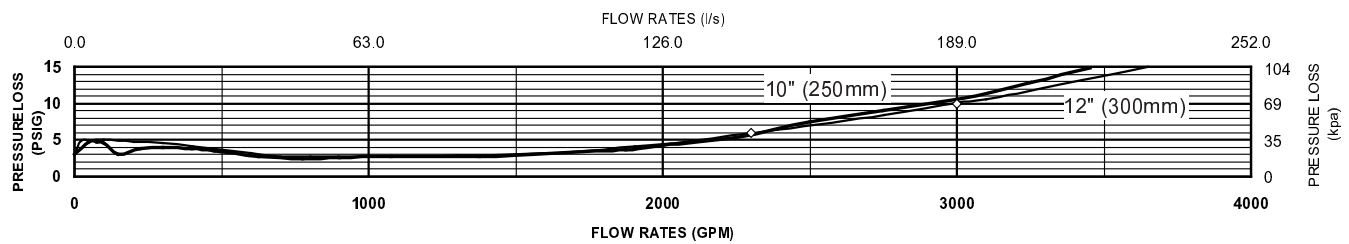

Typical Installation

Local codes shall govern installation requirements. Unless otherwise specified, the assembly shall be mounted at a minimum of 12" (305mm) and a maximum of 30" (762mm) above adequate drains with sufficient side clearance for testing and maintenance. The installation shall be made so that no part of the unit can be submerged.

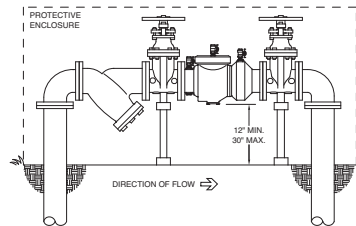

OUTDOOR INSTALLATION

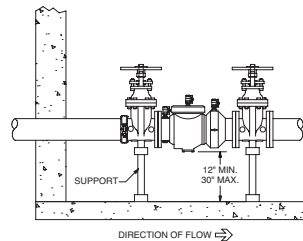

**INDOOR INSTALLATION
(350GF)**

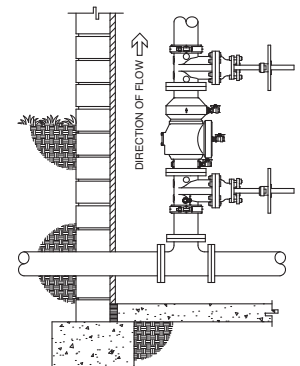

**VERTICAL INSTALLATION
(350G)**

Capacity thru Schedule 40 Pipe (GPM)				
Pipe size	5 ft/sec	7.5 ft/sec	10 ft/sec	15 ft/sec
2 1/2"	75	112	149	224
3"	115	173	230	346
4"	198	298	397	595
6"	450	675	900	1351
8"	780	1169	1559	2339
10"	1229	1843	2458	3687
12"	1763	2644	3525	5288

Specifications

The Double Check Backflow Prevention Assembly shall be certified to NSF/ANSI 61, ASSE® Listed 1015, and supplied with full port gate valves. The main body and access cover shall be epoxy coated ductile iron (ASTM A 536), the seat ring and check valve shall be NORLYL™, the stem shall be stainless steel (ASTM A 276) and the seat disc elastomers shall be EPDM. The checks shall be accessible for maintenance without removing the device from the line. The Double Check Backflow Prevention Assembly shall be a ZURN WILKINS Model 350.