

CODE NUMBER

10021304

DESCRIPTION

SU-1009 Urinal and ROYAL 186 ESS Flushometer.

COMPONENTS

- Flushometer: Code 3452641
- Urinal: Code 1101009

DETAILS

- Flush Volume: 0.25 gpf (0.9 Lpf)
- Nominal Dimensions: 14 ¼" x 17 ¼" x 25 ½" (362 x 438 x 648mm)

FLUSHOMETER FEATURES

- PERMEX® Synthetic Rubber Diaphragm with Dual Filtered Fixed Bypass
- Handle Packing, Main Seat, Stop Seat and Vacuum Breaker Molded from PERMEX® Rubber Compound for Chloramine resistance
- User friendly three (3) second Flush Delay
- Sweat solder adapter with cover tube and cast wall flange with set screw
- OPTIMA® EL-1500 Self-Adaptive Infrared Sensor with Indicator Light
- "Walk By" Delay of Eight (8) Seconds Prevents Unintentional Flushes
- Non-Hold-Open True Mechanical Override
- Non-Hold-Open Integral Solenoid Operator, Fixed Metering Bypass and No External Volume Adjustment to Ensure Water Conservation
- Courtesy Flush™ Non-Hold-Open True Mechanical Override
- High Back Pressure Vacuum Breaker Flush Connection with One-Piece Bottom Hex Coupling Nut, Spud Coupling and Flange for ¾" Top Spud
- ¾" I.P.S. Screwdriver Bak-Chek® Angle Stop with Vandal Resistant Stop Cap

FIXTURE FEATURES

- White Vitreous China
- Washdown flushing action
- Integral flushing rim
- ¾" I.P.S. top spud inlet
- 2" NPT outlet flange
- Vandal resistant strainer assembly included
- All mounting hardware included
- 100% factory flush tested



COMPLIANCES & CERTIFICATIONS



(ADA Compliant, cUPC Green Certified, UL Certified, WaterSense Listed, BAA Compliant, Satisfies LEED Credits)

DOWNLOADS

- [Standard Spud Urinal Installation Instructions](#)
- [SS/ST/SU/WETS/WEUS Fixtures Repair and Maintenance Guide](#)
- [Additional Downloads](#)

NOTES

All information contained within this document subject to change without notice.

ROUGH-IN

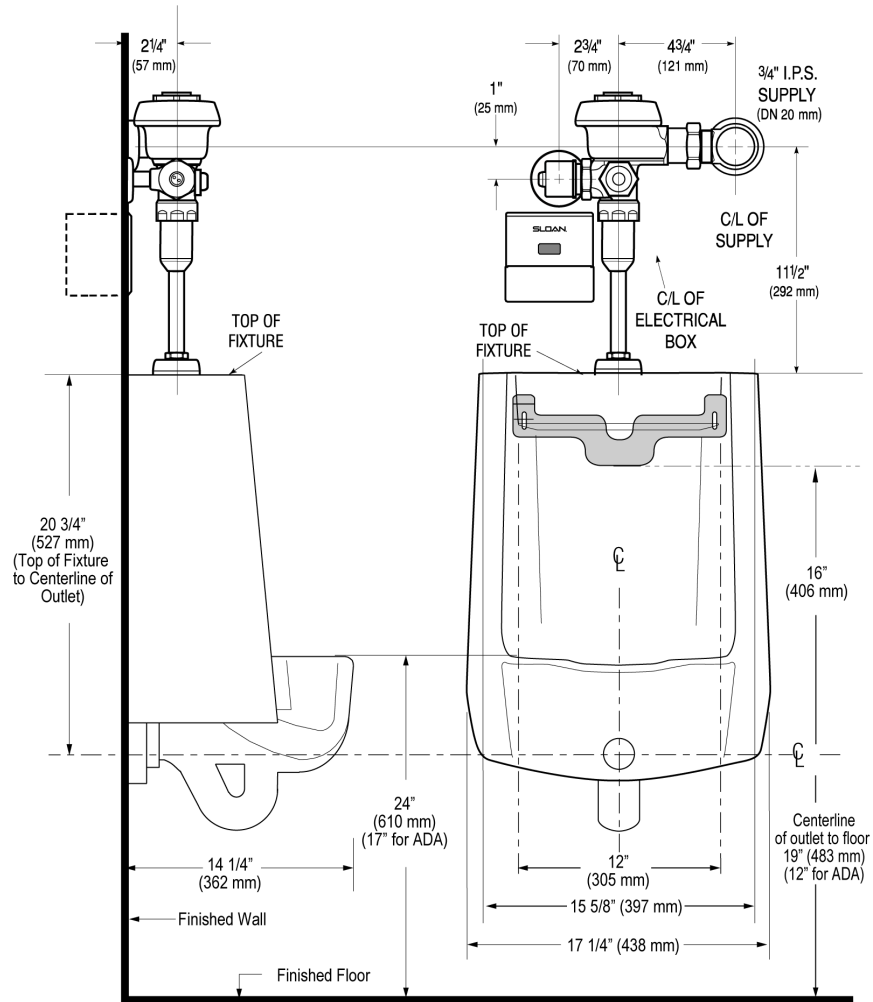

Sloan 10500 Seymour Ave, Franklin Park, IL 60131

Phone: 800.982.5839 • Fax: 800.447.8329 • sloan.com