



Poplin® Marabou®
 Medicine Cabinet Surround
K-99663-24

Features

- Designed to fit K-99006-NA and K-99007-NA Verdera medicine cabinets (sold separately).
- Coordinates with Poplin and Marabou vanities.
- Catalyzed conversion varnish provides a durable moisture-resistant finish.
- Mounts directly to wall for easy installation.

Material

- Solid wood and veneers.

Recommended Products/Accessories

- K-99007-TL Lighted Medicine Cabinet
- K-99006 Medicine Cabinet
- K-99007-SCF Medicine Cabinet

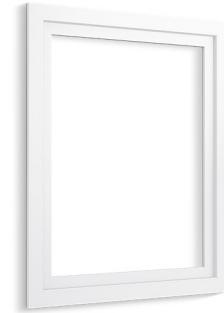

Codes/Standards









EPA TSCA Title VI
 CARB P2

KOHLER® One-Year Limited Warranty

See website for detailed warranty information.

Available Colors/Finishes

Color tiles intended for reference only.

Color	Code	Description
	1WA	Linen White
	1WG	Cherry Tweed
	1WB	Claret Suede
	1WH	Woolen Oak
	1WC	Felt Grey
	1WE	Terry Walnut
	1WT	Mohair Grey
	1WU	Batiste Black

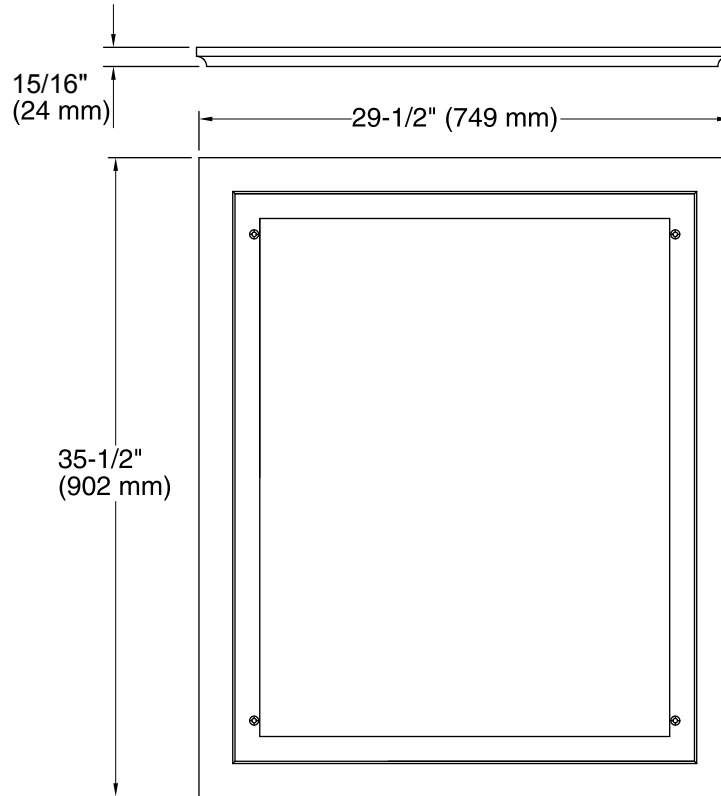

Technical Information

All product dimensions are nominal.

Notes

Install this product according to the installation guide.