

Features

- 71-3/4"L x 36"W x 20-7/8"H
- Contoured drain overflow allows comfortable bathing at either end or room for two
- Drop-in or undermount installation
- Constructed KOHLER® Cast Iron
- Designed for two-person bathing
- Removable pillow and bath drain not included.

Additional Hydrotherapy Options

- Soaking Bath - K-863-0
- BubbleMassage air bath - K-865-G0
- Whirlpool - K-865-H2
- Whirlpool + neck jets - K-865-N1

Required Products/Accessories

K-7169-AF 1-1/2" Contoured Pop-up Drain

Recommended Products/Accessories

K-582 Under-Mount Installation Kit
K-1179 Vinyl Tiling-in Bead
K-1601 Bath/Whirlpool Footstop



Codes/Standards















ASME A112.19.1/CSA B45.2
ASTM F462

KOHLER® Enameled Cast Iron Bath and Shower Base Lifetime Limited Warranty

See website for detailed warranty information.

Available Colors/Finishes

Color tiles intended for reference only.

Color	Code	Description
	0	White
	96	Biscuit
	47	Almond
	NY	Dune
	Y2	Sunlight
	95	Ice™ Grey
	G9	Sandbar
	33	Mexican Sand™
	6	Skylight
	K4	Cashmere
	58	Thunder™ Grey
	7	Black Black™
	GRL	Grey Lavender
	DGB	Indigo Blue
	PLM	Black Plum

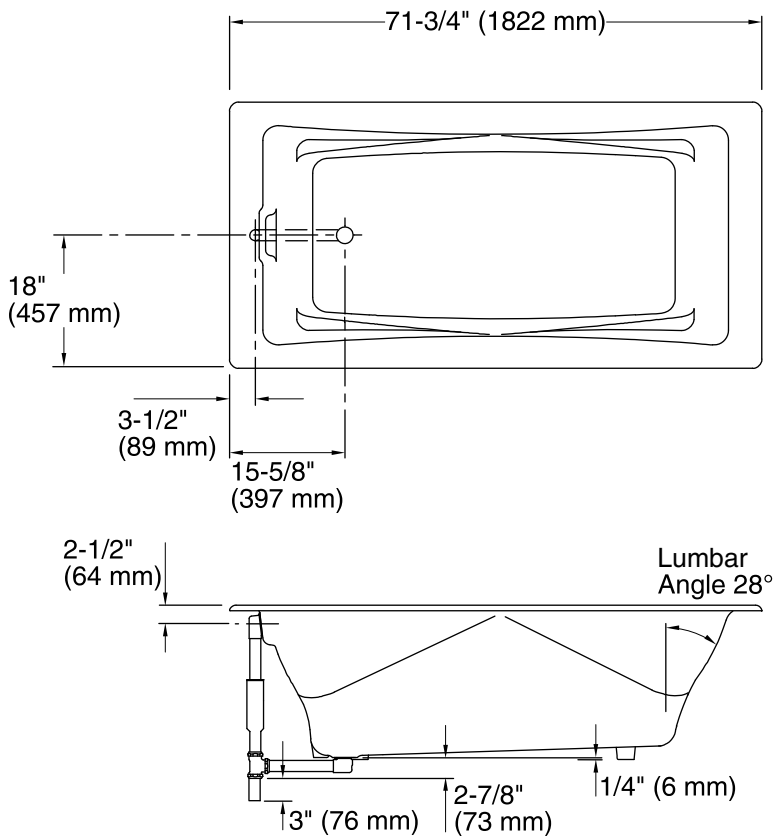

No change in measurements if connected with drain illustrated. (K-7169-AF)

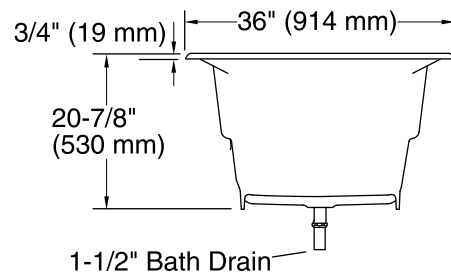

Technical Information

All product dimensions are nominal.

Installation:	Drop-in, Under-mount
Drain location:	End
Basin area, bottom:	49" x 22" (1245 mm x 559 mm)
Basin area, top:	62" x 28" (1575 mm x 711 mm)
Weight:	404 lbs (183.3 kg)
Minimum floor load:	65 lbs/ft ² (317.4 kg/m ²)
Water depth:	17" (432 mm)
Water capacity:	89 gal (336.9 L)
Cutout:	Drop-in, 70-1/4" x 34-1/2" (1784 mm x 876 mm)
Template:	Under-mount, K-582, required, not included
Minimum flat for door:	2-1/4" (57 mm)

Notes

Measure your actual product for rough-in details. Install this product according to the installation instructions.

The hot water supply should be 70% of the capacity of the bath or greater. Installations will vary.

Kit is required for under-mount installations (sold separately).